

**BUILT-IN OVEN
ANKASTRE FIRIN
FOUR ENCASTRABLES**

OIM 22501

BEKO

Please read this manual first.

Dear Customer,

We would like you to obtain best performance with your product that has been manufactured in modern facilities and passed through strict quality control procedures.

Therefore, we advise you to read through this User Manual carefully before using your product and keep it for future reference. If you hand over the product to someone else, deliver the User Manual as well.

The User Manual will help you use the product in a fast and safe way.

- Read the User Manual before installing and starting the product.
- You must strictly observe the safety instructions.
- Keep this User Manual within easy reach for future reference.
- Also read other documents supplied with the product.
Remember that this User Manual may also be applicable for several other models.
Differences between models are explicitly identified in the manual.

Explanation of symbols

Throughout this User Manual the following symbols are used:

 Important information or useful hints about usage.

 Warning for hazardous situations with regard to life and property.

 Warning for electric shock.

 Warning for risk of fire.

 Warning for hot surfaces.



Arçelik A.Ş.
Karaağaç caddesi No:2-6
34445 Sıtlüce/Istanbul/TURKEY
Made in TURKEY

Table of Contents

1	General information	4
	Overview	4
	Technical Data	5
	Accessories supplied with the unit.....	5
2	Safety instructions	7
	Basic safety instructions.....	7
	Safety when working with electricity .	8
	Intended use	8
	Safety for children	8
3	Installation	9
	Before installation	9
	Installation and connection.....	10
	Disposal	12
	Disposing of packaging material	12
	Old equipment.....	12
	Future transportation.....	13
4	Preparation	14
	Tips for saving energy	14
	Initial operation	14
	Setting the time	14
	First cleaning of the appliance	15
	Initial heating	15
5	How to operate the oven	16
	General information on baking, roasting and grilling	16
	How to use the electric oven	16
	Operating modes.....	18
	How to operate the oven control unit	21
	How to use the program lock	23
	How to use the alarm clock.....	24
	Cooking times table.....	25
	How to operate the grill	27
	Cooking times table for grilling.....	27
6	Maintenance and care	28
	General information	28
	Cleaning the control panel	28
	Cleaning the oven	28
	Removal of oven door.....	28
	Taking off the door inner glass	29
	Replacing the oven lamp	30
7	Troubleshooting	31

1 General information

Overview

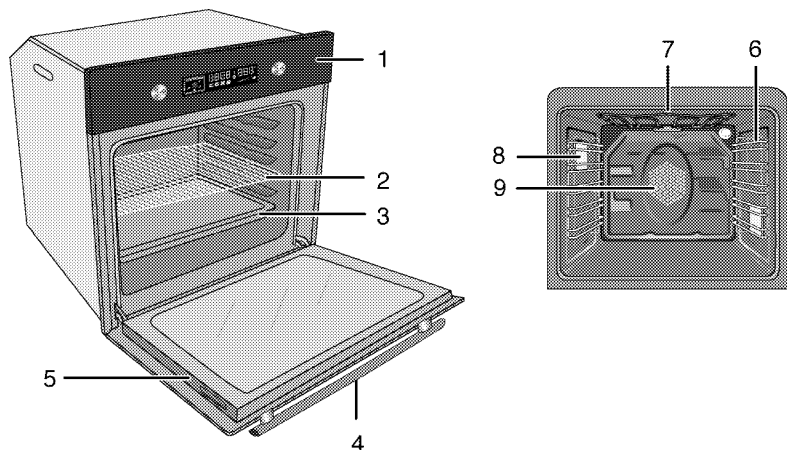

- | | | | |
|---|---------------|---|--------------------------------|
| 1 | Control panel | 6 | Shelf positions |
| 2 | Wire shelf | 7 | Top heating element |
| 3 | Tray | 8 | Lamp |
| 4 | Handle | 9 | Fan motor (behind steel plate) |
| 5 | Door | | |

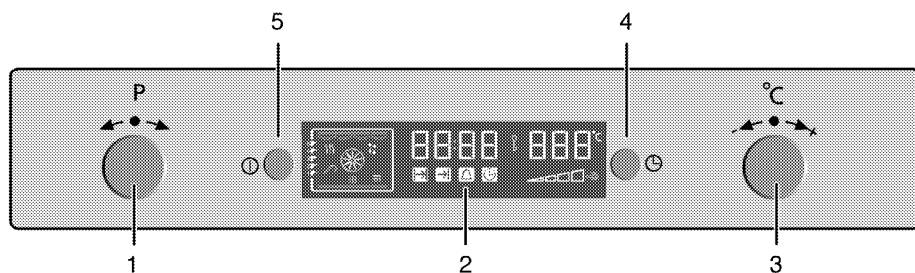

- | | | | |
|---|---|---|---------------|
| 1 | Function knob | 4 | Menu button |
| 2 | Digital timer | 5 | ON/OFF button |
| 3 | Temperature-time increase/decrease button | | |

Technical Data

Voltage/frequency	220-240 V ~ 50 Hz
Total electric consumption	3.1 kW
Fuse protection	min. 16 A
Cable type / cross section	H05VV-FG 3 x 1,5 mm ²
Cable length	max. 2 m
Outer dimensions (height/width/depth)	595 mm/594 mm/567 mm
Installation dimensions (height/width/depth)	**590 or 600 mm/560 mm/min. 550 mm
Main oven	Multifunction oven
Energy efficiency class [#]	A
Inside illumination	15/25 W
Grill power consumption	2.2 kW

[#] Basis: In electrical ovens, the data on energy labels are in conformity with EN 50304. Values were determined under standard load and convection/hot air (if available). Heating mode with an energy efficiency rating specified by EN 50304 is determined in accordance with below priority order depending on functions (modes) availability on the product. 1- Eco fan heating, 2-Slow cooking, 3-Fan heating (hot air), 4-Top and bottom heat with convection air, 5-Top and bottom heating.

** See *Installation*, page 9.

Accessories supplied with the unit

 Accessories supplied can vary depending on the product model. All the accessories described in the user manual may not exist on your product.

Baking tray

Can be used for pastries, frozen foods and big roasts.

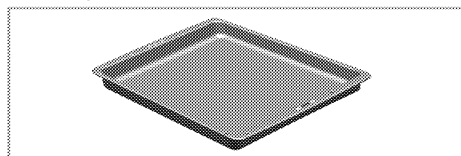

Deep roasting tray

Can be used for pastries, big roasts, foods with liquid content and during grilling as dripping pan.

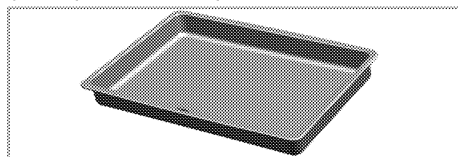

Pastry tray

It is recommended for pastries such as cookies and biscuits.

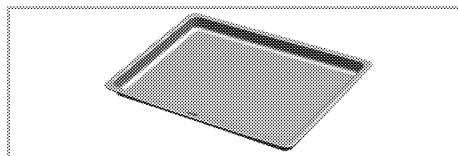

Small baking tray

Can be used for small portions. This baking tray is placed onto the wire shelf.

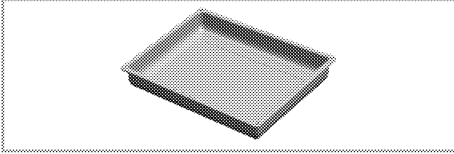

Wire shelf

Can be used for roasting and as deposit for baking, roasting and casserole dishes.

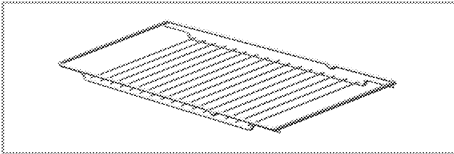
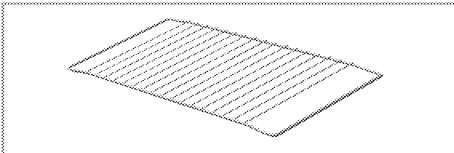

Proper positioning of the wire shelf and tray on sliding shelves

Trays and wire shelves used with the sliding shelf (model dependant) must be positioned correctly with the inner

edges of the shelf placed over the pins on the sliding shelf. This holds the shelf firmly in place".

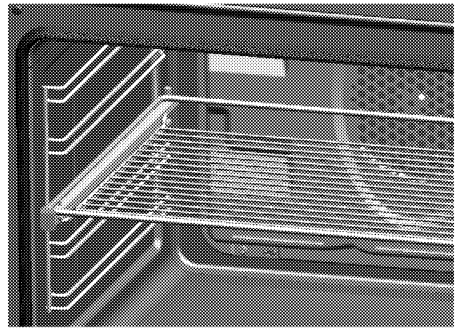
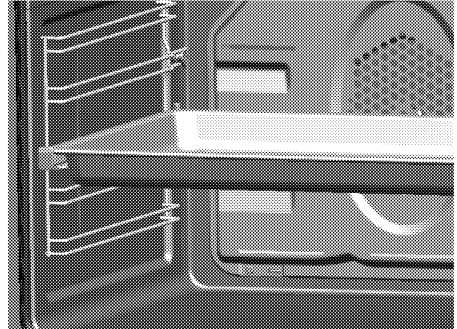

2 Safety instructions

Basic safety instructions

- The manufacturer reserves its right to make changes in the technical specifications in order to improve the appliance quality without any prior notice. Figures included in this manual are for schematic purpose only and may not match exactly with your appliance. Values stated on the markings of the appliance or in other printed documents supplied with the appliance are obtained under laboratory conditions as per relevant standards. These values may vary according to the usage of the appliance and ambient conditions.
- This appliance is not intended for use by persons (including children) with reduced physical, sensory or mental capabilities, or lack of experience and knowledge, unless they have been given supervision or instruction concerning use of appliance by a person responsible for their safety.
Children should be supervised to ensure that they do not play with the appliance.
- "An additional protective means to avoid contact with the oven door is available. This part should be fitted when young children are likely to be present."
- Never use when judgement or coordination is impaired by the use of alcohol and/or drugs.
- Do not operate the appliance if it is defective or shows any visible damage.
- Do not carry out any repairs or modifications on the appliance. However, you may remedy some malfunctions; see *Troubleshooting*, page 31.
- Be careful when using alcoholic drinks in your dishes. Alcohol evaporates in high temperatures and may catch fire when it comes in contact with hot surfaces.
- Do not heat closed food containers and glass jars. Pressure that may build-up in the jar can cause it to burst.
- Ensure that no flammable materials are adjacent to the appliance as the sides become hot during use.
- Do not place baking trays, dishes or aluminium foil directly onto the bottom of the oven. The heat accumulation might damage the bottom of the oven.
Keep all ventilation slots clear of obstructions.
- Appliance may be hot when it is in use. Never touch the hot burners, inner sections of the oven, heating elements etc. Keep children away!
- Always use heat-resistant gloves when putting or removing the dishes into/from your oven.
- Don't use the cooker with front door glass removed.
- Rear surface of the oven gets hot when it is in use. Gas / Electric connection should not touch the

rear surface, otherwise the mains cable may get damaged. Do not trap the mains cable between the hot oven door and frame. Do not route the mains cable over the hot cooking section. Otherwise, cable insulation may melt and cause fire as a result of short circuit.

- Check all controls on the appliance are switched off after use.

 For the warranty to be valid, the appliance must be installed by a qualified person in accordance with current regulations.

Safety when working with electricity

- Any work on electric equipment and systems may only be carried out by authorized qualified persons.
- Even if the oven is off, the cooling fan continues working for a while after turning off the oven.
- In case of any damage, switch off the appliance and disconnect it from the mains supply by removing the fuse or switching off the circuit breaker.
- Ensure that the fuse rating is correct.

Intended use

This product is designed for domestic use. Commercial use is not admissible. This product should not be used for warming the plates under the grill, drying towels, dish cloths and etc. by hanging them on the handles and for heating purposes.

The manufacturer shall not be liable for any damage caused by improper use or handling.

The oven can be used for defrosting, baking, roasting and grilling food.

Safety for children

- Accessible parts of the appliance will become hot whilst the appliance is in use and until the appliance has cooled, children should be kept away.
- Accessible parts may be hot when the grill is in use. Young children should be kept away.
- The packaging materials will be dangerous for children. Keep the packaging materials away from children. Please dispose of all parts of the packaging according to environmental standards.
- When the door is open, do **not** load any heavy object on it and do **not** allow children to sit on it. It may overturn or door hinges may get damaged.

3 Installation

Before installation

The appliance is intended for installation in commercially available kitchen cabinets. A safety distance must be left between the appliance and the kitchen walls and furniture. See figure (values in mm).

- Surfaces, synthetic laminates and adhesives used must be heat resistant (100 °C minimum).
- Kitchen cabinets must be set level and fixed.
- If there is a drawer beneath the oven, a shelf must be installed between oven and drawer.

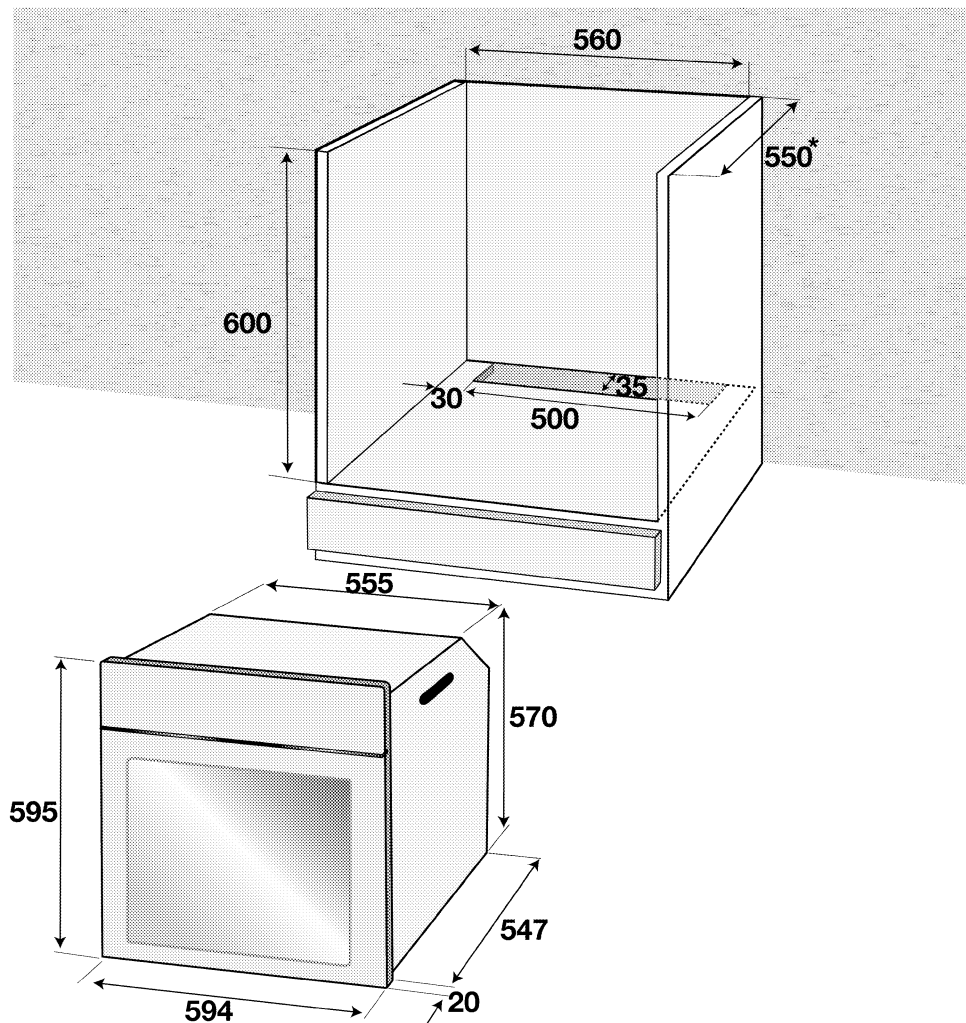

* min.

- Use the slots or wire handles located at both sides to move the appliance.
- ❗ If the appliance has wire handles, push the handles back into the side walls after moving the appliance.

Connection to the mains supply

❗ This appliance must be earthed!

Our company shall not be held responsible for any damage caused by using the appliance without an earthed socket.

⚠ Risk of electric shock, short circuit or fire by unprofessional installation!

The appliance may be connected to the mains supply only by an authorized qualified person and the appliance is only guaranteed after correct installation.

⚠ Risk of electric shock, short circuit or fire by damage of the mains lead!

The mains lead must not be clamped, bent or trapped or come into contact with hot parts of the appliance.

If the mains lead is damaged, it must be replaced by a qualified electrician.

- The mains supply must correspond to the data specified on the rating plate of the appliance. The rating plate can be seen when the front door is opened.
- The appliance mains cable must correspond to the specifications

and the power consumption; see *Technical Data, page 5*.

⚠ Risk of electric shock!
Before starting any work on the electrical installation, please disconnect the appliance from the mains supply.

1. If no all-pole separation from the mains supply is possible, a separation unit must be connected with a contact distance of 3 mm min. (fuses, line safety switches, contactors) all poles which should be adjacent to (but not above) the cooker in accordance with IEE regulations. Failure to observe this instruction may result in operational problems and invalidation of the appliance warranty.

Additional protection by a residual current circuit breaker is recommended.

If a cable without a plug is provided together with your appliance;

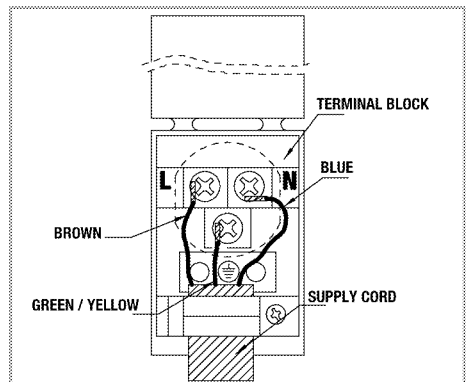

2. **for mono-phase connection**, take care to connect as below:

- Brown cable = L (Phase)
- Blue cable = N (Neutral)

- Green/yellow cable must be connected to ground (E) \equiv line.

Installation

1. Slide the oven through the cabinet aperture, align and secure.

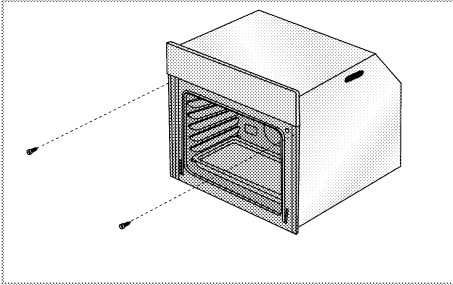

Fix your oven with the 2 screws and washers as indicated in the figure.

Final check

1. Connect the appliance to the mains supply and switch on the mains supply.
2. Check function.

For equipment with a cooling fan

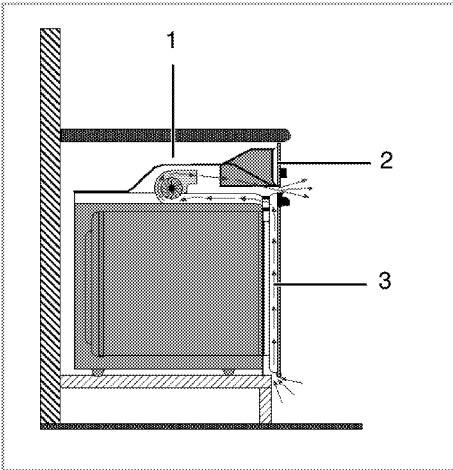

- 1 Fan
- 2 Control panel
- 3 Door

The Built-in cooling fan cools both the built-in cabinet and the front of the appliance.

-  Cooling fan continues to run for up to 20-30 minutes (approx.) even after the oven is turned off.

Disposal

Disposing of packaging material

Packaging materials are dangerous to children. Keep packaging materials in a safe place out of reach of children. Packaging materials of the product are manufactured from recyclable materials. Dispose of them properly and sort in accordance with recycled waste instructions. Do not dispose of them with normal domestic waste.

Old equipment



This appliance bears the selective sorting symbol for waste electrical and electronic equipment (WEEE). This means that this appliance must be handled pursuant to European Directive 2002/96/EC in order to be recycled or dismantled to minimize its impact on the environment. For further information, please contact your local or regional authorities. Electronic appliances not included in the selective sorting process are potentially dangerous for the environment and human health due to the presence of hazardous substances.

Future transportation

-  Do not place other items on the top of the appliance. The appliance must be transported upright.

Store the appliance's original box and transport the appliance in its original carton. Follow the guidance marks that are printed on the carton.

-  Verify the general appearance of your equipment by identifying possible damage during the transportation.

To prevent the wire shelf and tray inside the oven from damaging the oven door, place a strip of cardboard onto the inside of the oven door that lines up with the position of the trays. Tape the oven door to the side walls.

If you do not have the original carton
Pack the appliance in bubble wrap or thick cardboard and tape it securely in order to prevent damage during transportation.

4 Preparation

Tips for saving energy

The following tips will help you to use your appliance in an ecological way and to save energy:

- Use dark coloured and enamel coated trays, since the heat transmission will be better.
- While cooking your meals, perform a preheating operation if it is advised in the user manual or cooking instructions.
- During cooking, do not open the oven door frequently.
- Try to cook more than one type of meal within the oven at the same time (You can cook two different meals at the same time by locating

cooking bowls on the same shelf).

It will be suitable to cook more than one meal after each other.

The oven will already be hot.

- Defrost frozen meals before cooking them.
- You can save energy by switching off your oven a few minutes before the end of the cooking time (The oven door should not be opened).

Initial operation

Before first usage of your appliance, don't forget to remove the sticker on the digital timer screen

Setting the time

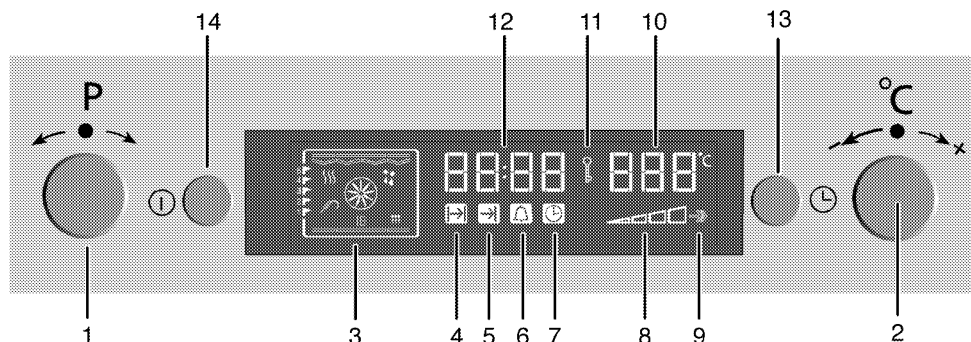

- 1 Program selection knob
- 2 Temperature-time increasing/decreasing knob
- 3 Function display

- 4 Cooking time symbol
- 5 Cooking end time symbol
- 6 Alarm period symbol
- 7 Current time symbol
- 8 Inner oven temperature symbol
- 9 Booster position
- 10 Temperature display

- 11 Keylock symbol
- 12 Current time display
- 13 Menu button
- 14 ON/OFF button

1. After switching on the oven for the first time, adjust the time of the day by slightly twisting the button **2** towards + or -.

-  If the current time is not set, time setting will start increasing up from **12:00**. Clock icon '7' will remain lit to indicate that the current time has not been set. This icon will disappear once the time is set.

Adjust the existing time

1. Activate the time of the day symbol '7' by pressing the button **13** twice for the time of the day.
2. Adjust the time of the day by slightly twisting the button **2** towards + or –.

-  Current time settings are cancelled in case of power failure. It needs to be readjusted. Time of the day can not be changed if the oven is operating in a function.

First cleaning of the appliance

-  The surface may get damaged by some detergents or cleaning materials.
Do not use aggressive detergents, cleaning powder/cream or any sharp objects.

1. Remove all packaging materials.
2. Wipe the surfaces of the appliance with a damp cloth or sponge and dry with a cloth.

Initial heating

-  Hot surfaces may cause burns!
Do not touch the hot surfaces of the appliance. Use oven gloves. Keep children away from the appliance.

-  Smell and smoke may emit during first heating. Ensure that the room is well ventilated.

Any production residues or conservation layers must be burnt off before the first use. Heat up the appliance for about 30 minutes and then switch it off.

Electric oven

1. Take all baking trays and racks from the oven.
2. Close oven door.
3. Select top and bottom heat with the function knob.
4. Select the highest temperature with the thermostat knob; see *How to use the electric oven, page 16*.
5. Heat approximately 30 minutes.
6. Switch off oven; see *How to use the electric oven, page 16*

Grill oven

1. Take all baking trays and wire shelf from the oven.
2. Close oven door.
3. Select highest power of the grill; see *How to operate the grill, page 27*.
4. Heat approximately 30 minutes.
5. Switch off grill; see *How to operate the grill, page 27*

5 How to operate the oven

General information on baking, roasting and grilling

- ⚠ Risk of scalding by hot steam!
Take care when opening the oven door as steam may escape.

Tips for baking

- Use non-stick coated appropriate metal plates or aluminum containers or heat-resistant silicone moulds.
- Make best use of the space on the rack.
- It is recommended to place the baking mould in the middle of the rack.
- Select the correct shelf position before turning the oven or grill on - don't move oven shelves when hot.
- Keep the oven door closed.

Tips for roasting

- Seasoning with lemon juice and black pepper will improve the cooking performance when cooking a whole chicken, turkey or a large piece of meat.
- Meat with bones takes about 15 to 30 minutes longer before it is cooked than a roast of the same size without bones.
- You should calculate about 4 to 5 minutes cooking time per centimeter height of the meat.
- Let meat rest in the oven for about 10 minutes after the cooking time. The juice is better distributed all over the roast and does not run out when the meat is cut.

- Fish in a fire-resistant dish should be placed on the rack at the medium or lower level.

Tips for grilling

Grilling is ideal for cooking meat, fish and poultry and will achieve a nice brown surface without it drying out too much. Flat pieces, meat skewers and sausages are particularly suited for grilling as are vegetables with a high water content such as tomatoes and onions.

- Distribute the pieces to be grilled on the wire shelf.
- If the grilling is on the wire shelf, locate a dripping pan under it in order to collect the fat.
- Add some water in the dripping pan for easy cleaning.

How to use the electric oven

All knobs of your oven are of the pop-out type.

1. Make your adjustment once you have pressed the knob in and it pops out.

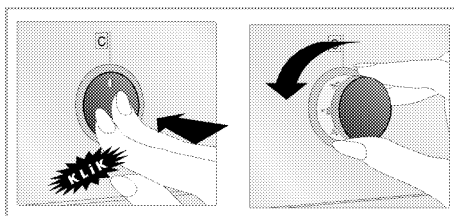

- » To reset, push in the knob upon completion of your adjustment.

Turning the oven on

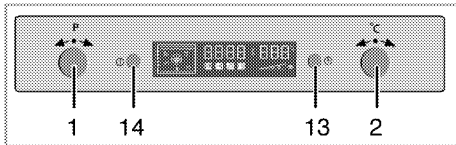

- 1 Function knob
- 2 Temperature-time increase/decrease button
- 13 Menu button
- 14 ON/OFF button

1. Press button **14** for about 1 second to turn the oven on.

Select temperature and operating mode

After turning the oven on; nothing appears at the function display.



-  Oven will switch off automatically within 10 seconds if no oven setting is made on this screen.

Temperature, cooking time, cooking end time and booster can be set in this position.

1. Slightly turn the button no. **1** to left or right so that the desired function;
 2. You can adjust the desired temperature by slightly twisting the button **2** towards + and -.
- » Your oven will readily start operating in the desired function and will increase the inner temperature to the set temperature.

» Active heaters and suggested tray position appear on the function display.
 » If no temperature setting is made previously, then the suggested temperature for the selected function is indicated on the temperature display. Function table contains the functions that can be used as well as minimum and maximum temperatures that can be selected in the oven.

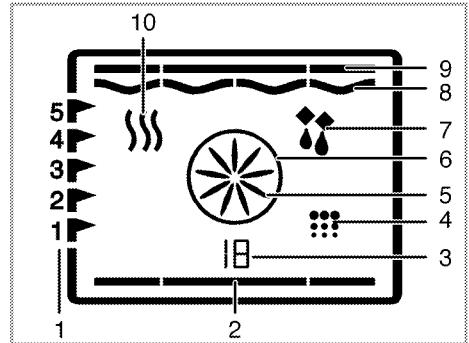

- 1 Shelf position
- 2 Bottom heater
- 3 Function number
- 4 Cleaning position
- 5 Turbo fan
- 6 Turbo heater
- 7 Defrost position
- 8 Grill heater
- 9 Upper heater
- 10 Warm keeping
- * Functions can vary depending on the product model!

Function table :

Function	Suggested temperature (°C)	Temperature range (°C)
Static	200	40-280
Static + fan	175	40-280
Fan heating	180	40-280
3 D	205	40-280
Pizza	210	40-280
Grill	280	40-280

Function	Suggested temperature (°C)	Temperature range (°C)
Low grill	280	40-280
Eco fan heating	180	160-220
Bottom heater	180	40-220
Warm keeping	60	40-100

i Maximum time that can be set for cooking period is limited with 6 hours at positions apart from keeping warm due to safety reasons. In case of power cut, program will be canceled. Reprogram is needed.

i While making any adjustment, related symbols on the clock will flash.

i Time of the day can not be adjusted when the oven is operating in any function or the clock is set to a semi-automatic or full automatic program.

i Even if the oven is off, oven lamp lights up when the oven door is opened.

Switch off electric oven

Press button **14** for about 2 seconds to turn the oven off.

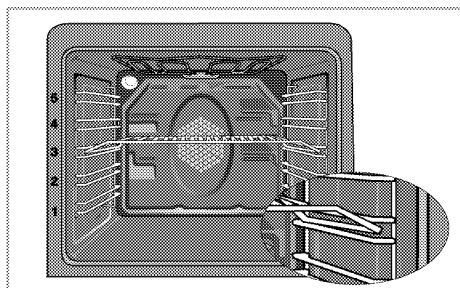

Shelf positions (model dependant)

It is important to position the wire grill on wire shelf correctly. The wire grill must be placed so that it will fit into

the opening of the wire shelf as illustrated in the figure.

Operating modes

The order of operating modes shown here might deviate from the arrangement on your appliance.

1. Top and bottom heat



The foodstuffs are heated simultaneously from the upper and lower part. Suitable e.g. for cakes, cookies and casseroles in baking moulds. Cook with one tray only.

2. Top and bottom heat with convection air



Warm air heated by the lower and upper heaters is evenly distributed throughout the oven very fast by means of the fan. Cook with one tray only.

3. Hot air



Warm air heated by the rear heater is evenly distributed throughout the oven very fast by means of the fan. It is suitable for cooking your

meals in different shelf levels and preheating is not required in most cases. Suitable for cooking with multi trays.

4. **"3D" function**

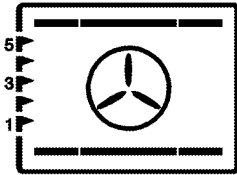

Top heat, bottom heat plus ring heat with fan (in the rear wall) are on. The appliance to be cooked is evenly and quickly cooked all around. Cook with one tray only.

5. **Pizza function**

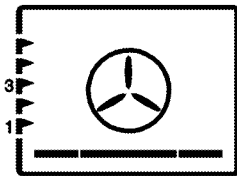

The bottom heat and the heating ring with fan (in the rear wall) are in operation. Suitable for baking pizza.

6. **Strong grill with convection air**



Warm air heated by the large grill is distributed very fast in the oven by means of the fan. It is suitable for grilling large amount of meat.

- Put big or medium-sized portions in correct shelf position under the grill heater for grilling.

- Set the temperature to maximum level.
- Turn the food after half of the grilling time.

7. **Surface grill**

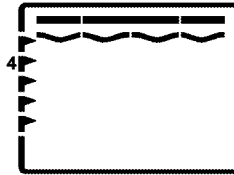

The large grill (under the oven roof) is in operation. Suitable for grilling larger quantities.

- Put big or medium-sized portions in correct shelf position under the grill heater for grilling.
- Set the temperature to maximum level.
- Turn the food after half of the grilling time.

8. **Grill-small**

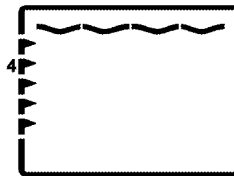

The grill (under the oven roof) is in operation. Suitable for grilling.

- Put small or medium-sized portions in correct shelf position under the grill heater for grilling.
- Set the temperature to maximum level.
- Turn the food after half of the grilling time.

9. Eco fan heating

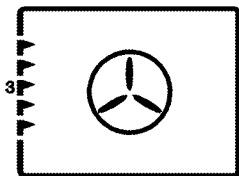

To save power, you can use this function instead of the cooking operations that you would perform by using turbo cooking at 160-220°C temperature range. But, the cooking time will increase a little bit.

Cooking times for this mode is given 'Eco fan heating' table.

10. Bottom heat



Only bottom heat is on. Is particularly suitable for dishes, such as pizza, which are required to be baked from bottom.

11. Warm keeping

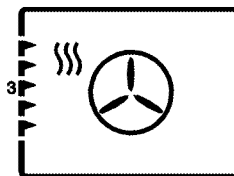

Can be used for keeping food warm at low temperature and over a longer period of time.

12. Operating with fan



The oven is not heated. Only the fan (in the rear wall) is in operation. Frozen granular food is thawed slowly at room temperature and cooked food is cooled down.

i When the oven door is opened, the fan motor will not run to keep the hot air inside.

How to operate the oven control unit

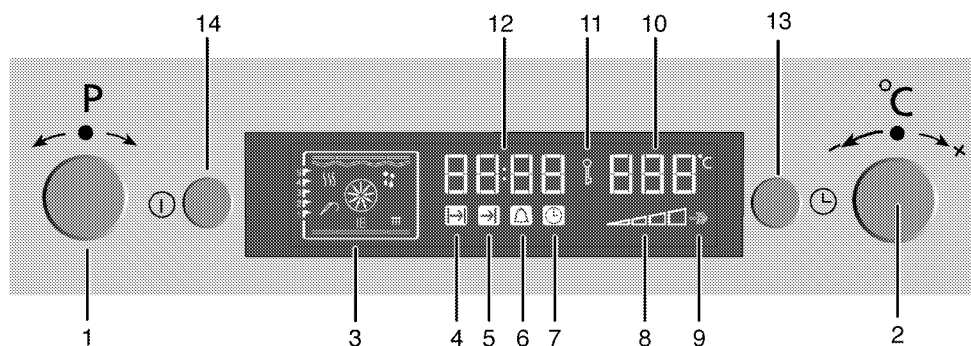

- 1 Program selection knob
- 2 Temperature-time increasing/decreasing knob
- 3 Function display
- 4 Cooking time symbol
- 5 Cooking end time symbol
- 6 Alarm period symbol
- 7 Current time symbol
- 8 Inner oven temperature symbol
- 9 Booster position
- 10 Temperature display
- 11 Keylock symbol
- 12 Current time display
- 13 Menu button
- 14 ON/OFF button

Switch on semi-automatic operation

In this operation mode, you may adjust the time period during which the oven will operate (cooking time). Oven starts to operate after the settings are made and runs at the set temperature throughout the cooking time. Oven turns off at the end of the cooking time.

1. Turn on the oven by pressing and holding button '14'.
2. Adjust the desired operation mode (function) by slightly twisting the button '1' towards right or left hand.

3. Activate the cooking time symbol '4' by pressing the button '13' with while the oven is operating.
4. Adjust the cooking time by slightly twisting the button 2 towards "+" or "-".
 - » Cooking time symbol '4' remains lit after adjusting the cooking time.
5. Place your dish in the oven.
6. Adjust the cooking temperature by slightly twisting the button 2 towards "+" or "-".
 - » The oven will be heated up to the preset temperature and will maintain this temperature until the end of the cooking time you selected.

- i** All segments of the inner oven temperature symbol (8) will turn on when your oven reaches the set temperature.
7. After the cooking process is completed, "End" will be displayed and the alarm signal will sound.
 8. To stop the alarm signal, press button no. '13' or '14'.
 - » Alarm will be silenced, oven will be turned off automatically and current time will be displayed on the screen.

Switch on automatic operation

In this operation mode you may adjust how long the oven will be operate (cooking time) and when it will be turned off (cooking end time).

1. Turn on the oven by pressing and holding button **'14'**.
2. Adjust the desired operation mode (function) by slightly twisting the button **'1'** towards right or left hand.
3. Activate the cooking time symbol **'4'** by pressing the button **'13'** with while the oven is operating.
4. Adjust the cooking time by slightly twisting the button **2** towards **"+"** or **"-"**.

» Cooking time symbol **4** remains lit after adjusting the cooking time.

5. Activate the cooking end time symbol **(5)** by pressing the button **13** with short intervals.
6. Adjust the cooking end time by slightly twisting the button **'2'** towards **"+"** or **"-"**.

» Cooking end time symbol **(5)** remains lit after adjusting the cooking end time.

7. Place your dish in the oven.
8. Adjust the cooking temperature by slightly twisting the button **'2'** towards **"+"** or **"-"**.

» Oven timer automatically calculates the startup time for cooking by using the end of cooking time you have set and the cooking period. Selected operation mode is activated when the startup time of cooking has come and the oven is heated up to the set temperature. It maintains this temperature until the end of the cooking time. Oven lamp lights up during cooking.

 All segments of the inner oven temperature symbol **(8)** will turn on when your oven reaches the set temperature.

9. After the cooking process is completed, **"End"** will be displayed and the alarm signal will sound.

10. To stop the alarm signal, press button no. **'13'** or **'14'**.

» Alarm will be silenced, oven will be turned off automatically and current time will be displayed on the screen. Oven lamp will also switch off.

 If you want to cancel the semi-automatic or automatic programming after you have set them, you need to reset the cooking time.

Setting the Booster (Quick Preheating)

It can be used to reach to the desired inner oven temperature more quickly by operating the oven heaters in a combination different than the selected function.

 Booster function can only be set while the oven is operating. Booster function can not be selected in defrosting and cleaning modes. Booster setting is cancelled in case of power failure.

1. For booster function, press button **13** with short intervals until the booster symbol **(9)** becomes active.

» **"OFF"** will be displayed.

2. Activate the booster by slightly twisting the button **2** towards **"+"**.

» After the booster is adjusted, **"On"** will be displayed and the booster symbol will remain lit.

» Booster symbol turns off after the desired inner oven temperature is attained and oven resumes its operation with the function selected before the booster.

3. To cancel the booster function, press button **'13'** to activate the booster symbol **(9)**.

» **"On"** will be displayed.

4. Deactivate the booster by slightly twisting the button **2** towards **"-"**.

» **"OFF"** will be displayed.

How to use the program lock

Activate the program lock

You can prevent using of oven by activating the keylock feature.

 Keylock can be used either the oven is operating or not operating. Oven can still be turned off by keeping the button **14** pressed for 2 seconds even the key lock is activated while the oven is operating.

1. For keylock; press button **13** with short intervals until the keylock symbol **"11"** becomes active.

» **"OFF"** will be displayed.

2. Activate the keylock by slightly twisting the button **'2'** towards **"+"**.

» After the keylock is adjusted, **"On"** will be displayed and the keylock symbol will remain lit.

Deactivate the program lock

1. To deactivate the keylock, press button **"13"** with short intervals

until the keylock symbol **"11"** becomes active.

» **"On"** will be displayed.

2. Deactivate the keylock by slightly twisting the button **'2'** towards **"-"**.

» After the keylock is turned off, **"OFF"** is displayed and the keylock symbol **'11'** disappears.

 Oven buttons can not be used while the keylock function is active. Keylock function is not cancelled in a power failure.

How to use the alarm clock

In addition to using the timer for cooking, it can be also used as a reminder or an alarm clock.

As soon as the defined period of time has expired, the alarm clock will emit a signal. The alarm clock has no influence on the functions of the oven.

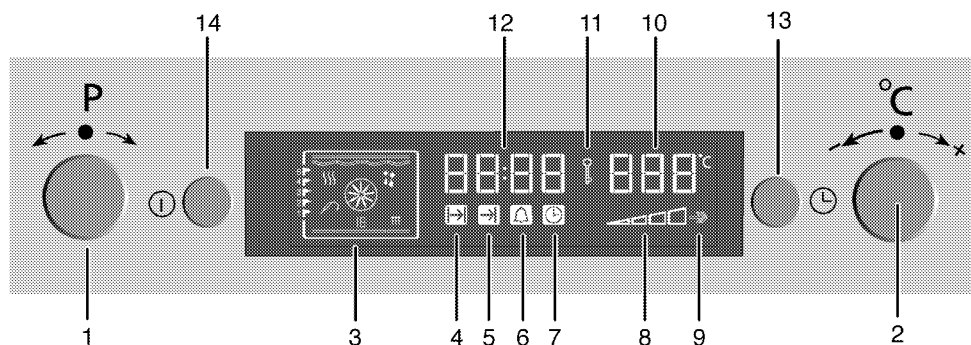

- 1 Program selection knob
- 2 Temperature-time increasing/decreasing knob
- 3 Function display
- 4 Cooking time symbol
- 5 Cooking end time symbol
- 6 Alarm period symbol
- 7 Current time symbol
- 8 Inner oven temperature symbol
- 9 Booster position
- 10 Temperature display
- 11 Keylock symbol
- 12 Current time display
- 13 Menu button
- 14 ON/OFF button

Using the clock as an alarm

Alarm clock does not have any effect on the oven functions. It is used as a warning.

For example, you can use alarm clock to warn you for turning the dish in the oven round in a certain time.

- i** The maximum alarm time can be 23 hours and 59 minutes.

- i** Alarm clock can be used either the oven is operating or not operating.

Setting the alarm clock

1. Press button '**13**' with short intervals until the alarm symbol '**6**' becomes active.
2. Adjust it by slightly twisting the button **2** towards "+" or "-".
 - » Alarm symbol remains lit after adjusting the alarm time.
3. After the alarm time is finished, alarm symbol will start flashing and an alarm signal is heard.
4. You can stop the alarm by pressing any button.

In order to cancel set alarm time;































1. To reset the alarm time, press button '**13**' to activate the alarm symbol (**6**).
2. Adjust it by slightly twisting the button '**2**' towards "-" until "**00:00**" is displayed.

Cooking times table

 The values indicated in the table below are data indicative. They may vary according to the type of food as well as your preferences of cooking.

Baking and roasting

 Level 1 is the **bottom** level in the oven.

Food	Cooking level number		Rack position	Temperature (°C)	Cooking time (min.) (approx.)
Cake in tray*	One level		3	175	25 ... 30
Cake in mould*	One level		2	180	40 ... 50
Cakes in paper*	One level		3	175	25 ... 30
	2 levels		1 - 5	175	30 ... 40
	3 levels		1 - 3 - 5	180	45 ... 55
Sponge cake*	One level		3	200	5 ... 10
	2 levels		1 - 5	175	20 ... 30
Cookies*	One level		3	175	25 ... 30
	2 levels		1 - 5	170 ... 190	30 ... 40
	3 levels		1 - 3 - 5	175	35 ... 45
Dough pastry*	One level		2	200	30 ... 40
	2 levels		1 - 5	200	45 ... 55
	3 levels		1 - 3 - 5	200	55 ... 65
Filled savory pastry*	One level		2	200	25 ... 35
	2 levels		1 - 5	200	35 ... 45
	3 levels		1 - 3 - 5	190	45 ... 55
Leaven*	One level		2	200	35 ... 45
	2 levels		1 - 3	190	35 ... 45
Lasagne*	One level		2 - 3	200	30 ... 40
Pizza*	One level		2	200 ... 220	15 ... 20
	One level		3	200	10 ... 15
Beefsteak (whole)/ Roast	One level		3	25 min. 250/max after 180 ... 190	100 ... 120
Lamb haunch (casserole)	One level		3	25 min. 250/max after 190	70 ... 90
	One level		3	25 min. 250/max after 190	60 ... 80
Roast chicken	One level		2	15 min. 250/max after 180 ... 190	55 ... 65
	One level		2	15 min. 250/max after 180 ... 190	55 ... 65
Turkey (5.5 kg)	One level		1	25 min. 250/max after 180 ... 190	150 ... 210
	One level		1	25 min. 250/max after 180 ... 190	150 ... 210
Fish	One level		3	200	20 ... 30
	One level		3	200	20 ... 30

Food	Cooking level number		Rack position	Temperature (°C)	Cooking time (min.) (approx.)
While cooking with 2 trays at the same time, place the deep tray to the upper shelf and shallow tray to the lower shelf. * It is suggested to perform preheating for all foods.					





(**) In a cooking that requires preheating, preheat at the beginning of cooking until the temperature symbol

(8) of the oven rises up to the highest level.

Eco fan heating

 Do not change the temperature during cooking in “Eco fan heating” mod.

 Do not open the door during cooking in “Eco fan heating” mod.

Food	Cooking level number		Rack position	Temperature (°C)	Cooking time (min.) (approx.)
Cakes in paper	One level		3	200	35 ... 40
Cookies	One level		3	200	30 ... 35
Dough pastry	One level		3	200	40 ... 45
Filled savory pastry	One level		3	200	40 ... 45

Tips for baking cakes

- If pastry is too dry,
 - » Increase the temperature by 10°C and reduce the cooking time.
- If pastry dropped,
 - » Use less liquid or lower the temperature by 10°C.
- If pastry is too dark on top,
 - » Place it on a lower rack, lower temperature, and increase the cooking time.
- If cooked well on the inside but sticky on the outside,
 - » Use less liquid, lower the temperature, and increase the cooking time.

Tips for baking pastry

- If the pastry is too dry,
 - » Increase the temperature some 10°C and decrease the cooking time.
 - » Dampen the layers of dough with a sauce composed of milk, oil, egg and yoghurt.

- If the pastry takes too long to bake,
 - » Pay care that the thickness of the pastry you have prepared does not exceed the depth of the tray and remain level with it.
- If the upper side of the pastry gets browned, but the lower part is not cooked,
 - » Make sure that the amount of sauce you have used for the pastry is not too much at the bottom of the pastry. Try to scatter the sauce equally between and on the dough layers for an even browning.
 - » Cook the pastry in accordance with the mode and temperature given in the cooking table. If the bottom part is still not browned enough, place it on a lower shelf next time.

Tips for cooking vegetables

- If the vegetable dish runs out of juice and gets to dry,
 - » Sthin using a lid during cooking will keep the juice of the dish in the pan,

cook your vegetable dishes in a pan with a lid instead of a tray.

2. If a vegetable dish does not get cooked,

» Boil the vegetables beforehand or prepare them like canned food and put in the oven.

How to operate the grill

 Hot surfaces may cause burns!
Close oven door during grilling.

Switch on grill

1. Press button **14** for about 1 second to turn the oven on.
2. Adjust the grill function by slightly twisting the button '1' towards right or left hand.
3. You can adjust the desired temperature by slightly twisting the button **2** towards + and –.

Switch off grill

1. Press button **14** for about 2 seconds to turn the oven off.

Shelf positions

For optimum grill coverage, position the wire shelf towards the front of the oven just out of contact with the glass door. Placing the wire shelf fully to the rear of the oven will reduce the grill coverage.

Cooking times table for grilling

Grilling with electric grill

Food	Insertion level	Grilling time (approx.)
Fish	4...5	20...25 min. [#]
Sliced chicken	4...5	25...35 min.
Lamb chops	4...5	20...25 min.
Roast beef	4...5	25...30 min. [#]
Veal chops	4...5	25...30 min. [#]
Toast bread	4	1...2 min.

[#] depending on thickness

6 Maintenance and care

General information

- ⚠ Risk of electric shock!
Switch off the electricity before cleaning appliance to avoid an electric shock.
- ⚠ Hot surfaces may cause burns!
Allow the appliance to cool down before you clean it.
- ⓘ The surface may get damaged by some detergents or cleaning materials.
Do not use aggressive detergents, cleaning powder/cream or any sharp objects.

Clean the appliance thoroughly after each use; in this way it will be possible to remove cooking residues more easily, thus avoiding these from burning the next time the appliance is used.

No special cleaning agents are required for cleaning the appliance. It is recommended to use warm water with washing liquid, a soft cloth or sponge and use a dry cloth for drying.

Do not use any abrasive cleaning materials!

- ⓘ Do not use steam cleaners for cleaning.

Cleaning the control panel

- ⓘ Damage of the control panel!
Do not remove the control knobs for control panel cleaning.

Clean control panel and control knobs.

Cleaning the oven

No oven cleaner or any other special cleaning agent is required for cleaning the oven. It is recommended to wipe the oven with a damp cloth while it is still warm.

To clean the side wall,

1. Remove the front section of the side rack by pulling it in the opposite direction of the side wall.
2. Remove the side rack completely by pulling it towards you.

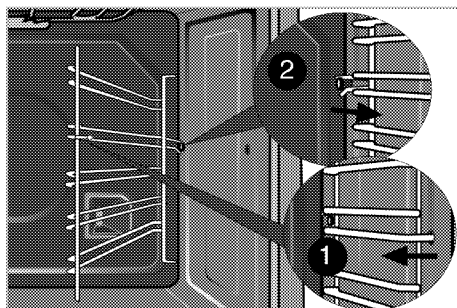

Catalytic walls

Side walls or just back wall of oven interior may be covered with catalytic enamel.

The catalytic walls of the oven must not be cleaned. The porous surface of the walls is self-cleaning by absorbing and converting spitting fat (steam and carbon dioxide).

Clean oven door

Don't use any harsh abrasive cleaners or sharp metal scrapers for cleaning the oven door. They could scratch the surface and destroy the glass.

Removal of oven door

1. Open the front door.

- Open the clips at the hinge housing on the right and left hand sides of the front door by pressing them down as illustrated in the figure.

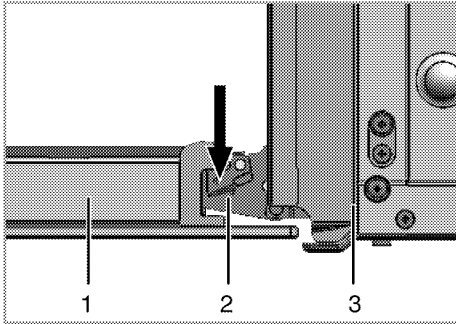

- Front door
- Hinge
- Oven

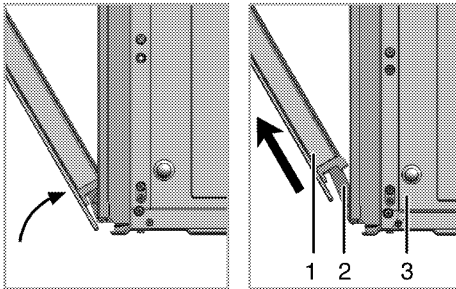

- Move the front door to half-way.
- Remove the front door by pulling it upwards to release it from the right and left hinges.

- i** Steps carried out during removing process should be performed in reverse order (steps 4, 3, 2 and 1) to reattach the door. Do not forget to close the clips at the hinge housing when reinstalling the door.

Taking off the door inner glass

The inner glass panel of the oven door can be removed for cleaning.

- Open oven door. Inner door glass of the oven is removable. In order to remove the inner door glass, use the spade supplied with the oven.

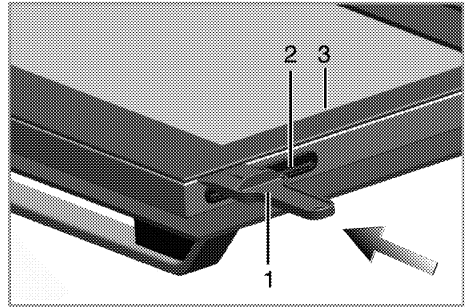

- Spade
- Plastic housing
- Inner glass

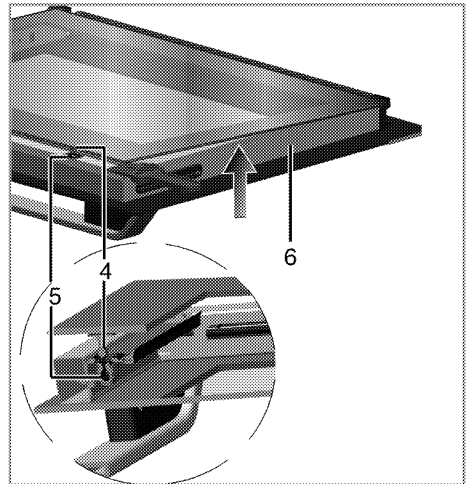

- Pin
- Pin housing
- Metal Frame

- Place the spade at the position indicated in the diagram and push in the direction indicated to remove the glass.

- In order to re-fit the glass, place the lower side of the glass to the plastic housings. Push the glass against the metal frame on the upper side to secure the pins to the housing.

Replacing the oven lamp

⚠ Hot surfaces may cause burns! Make sure that the appliance is switched off and cooled down in order to avoid the risk of an electrical shock.

The oven lamp is a special heat-resisting (T 300 °C) electric light bulb; see *Technical Data, page 5*. Oven lamps can be obtained from a good local electrical store.

i Position of lamp may vary from diagram.

1. Switch off the appliance at the mains.
2. Unscrew glass cover by turning anti-clockwise.

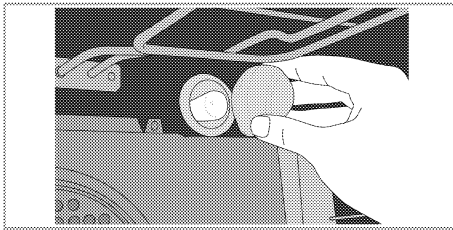

3. Unscrew oven lamp by turning anti-clockwise and replace it with new one.
4. Refit the glass cover.
 1. Switch off the current.
 2. Remove the side racks as explained, see *Cleaning the oven, page 28*.

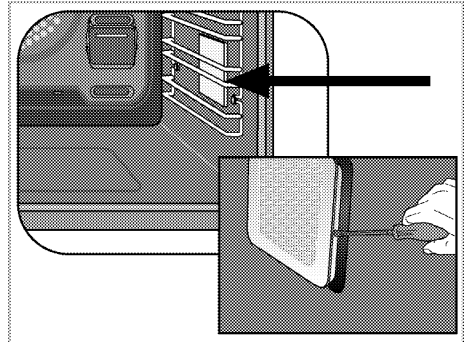

3. Lift glass cover with a screwdriver.
4. Unscrew oven lamp and replace it by a new one.
5. Insert glass cover and side racks again.

7 Troubleshooting

-  Risk of electric shock, short circuit or fire by unprofessional repairs!
Repairs on the appliance must be carried out by an approved service centre.

- It is normal that steam escapes during operation.
- When the metal parts are heated, they may expand and cause noise.

Before you call the service, please check the following points.

Normal operating conditions

- Smoke and smell may emit for a couple of hours during the first operation.

Electrical equipment

Malfunction/problem	Possible cause	Advice/remedy
The appliance does not work.	The mains fuse is defective or has tripped.	Check fuses in the fuse box. If necessary, replace or reset them.
	Timer buttons do not work.	Keylock may be enabled. Please disable it(See; <i>How to use the program lock, page 23</i>).
Oven light does not work	Oven lamp is defective.	Replace oven lamp.
	No current.	Check fuses in the fuse box. If necessary, replace or reset them.
Oven does not heat.	Function knob and/thermostat knob are not set.	Set function knob and thermostat knob.
	If the appliance has a timer, the timer may not be set.	Set the time.
	No power.	Check mains supply and fuse box.

If the problem has not been solved:

1. Separate unit from the mains supply (deactivate or unscrew fuse).
2. Call the after-sales service of your store reseller.

-  Do not attempt to repair the appliance yourself. There are no customer service items inside the appliance.